

Prises TV/SAT - TV/R/SAT (DAB+)

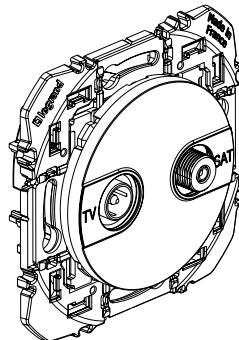

6 003 56/6 004 56

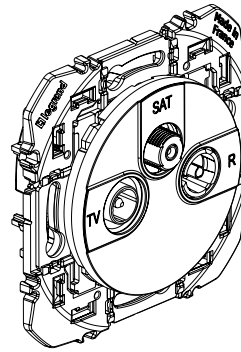

6 003 53/6 004 53

1. USAGE

TV/R/SAT (DAB+) : permet la réception des signaux TV, radio et satellite.
 Compatible UHD (Ultra Haute Définition) et DAB (Digital Audio Broadcasting ou radio numérique terrestre).
 Blindage Classe A - Cablage étoile
 Faible atténuation < 1,5 dB
 Câble recommandé 17 VATC
 Arrivée de câble unique

2. GAMME

Designation	Couleur	N° réf
Prise TV R SAT (DAB+)	Blanc	6 003 53
	Aluminium	6 004 53
Prise TV SAT	Blanc	6 003 56
	Aluminium	6 004 56

3. DIMENSIONS (mm)

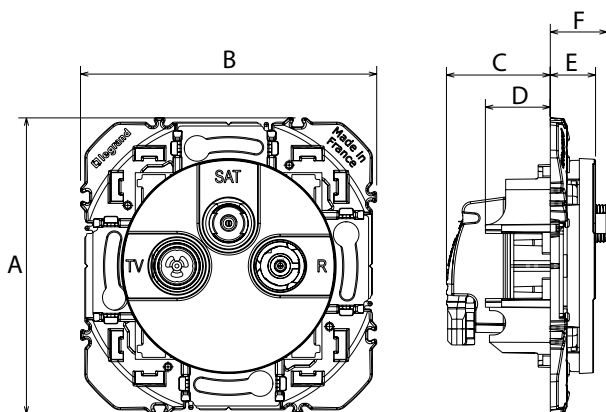

N° réf	A	B	C	D	E	F
6 003 53 6 004 53	73	73	25,6	16	11,15	14,05
6 003 56 6 004 56					11,1	14,1

4. CONNECTION

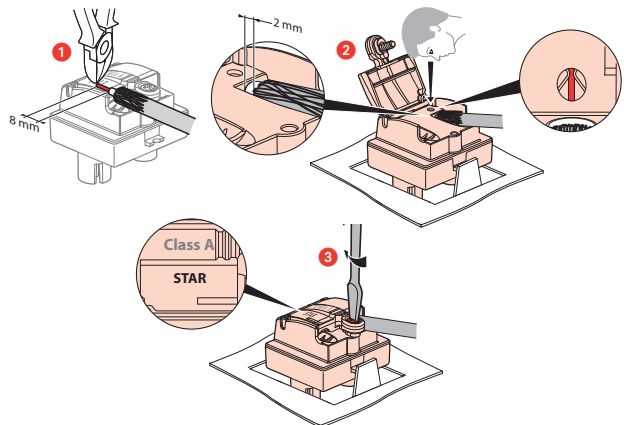

5. PRECAUTIONS DE CABLAGE

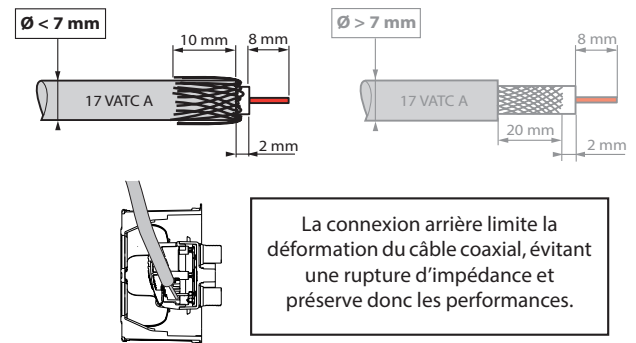

6. ENTRETIEN

Nettoyage superficiel au chiffon.
 Ne pas utiliser : acétone, dégraissant, trichloréthylène.
 Tenue aux produits suivants : Hexane (EN 60669-1), alcool à brûler, eau savonneuse, ammoniac dilué, javel pure diluée à 10 %, produit à vitres, lingettes pré-impregnées.

Attention : Pour l'utilisation de produits d'entretien spécifiques autres, un essai préalable est nécessaire.

Prises TV/SAT - TV/R/SAT (DAB+)**7. CARACTERISTIQUES TECHNIQUES****7.1 Caractéristiques mécaniques**

Essais aux chocs : IK04

Pénétration de corps solides/liquides : IP20

Tenue câble 120 N : norme IEC 61169-24

7.2 Caractéristiques matières**Matière :** - Enjoliveur : ABS

- Sans halogène

- Tenue aux UV

Moteur : - Boîtier : zamac

- Capot : zamac

- Broche : bronze

- Vis : acier zingué

7.3 Caractéristiques électriques

- Connecteur mâle Ø 9,52 mm (TV)

- Connecteur femelle (Radio)

- Connecteur type F femelle à visser (SAT)

- Impédance caractéristiques : 75 ohm

Efficacité de blindage classe A (le blindage classe A est nécessaire pour prévenir des interférences causées par l'usage des nouveaux signaux téléphone 3 et 4 G, ces signaux non désirés pouvant générer des pixelisations sur l'écran ou détériorer la bande son).

- Bandes de fréquence : TV : 5-68 /120-862 MHz
R : 87,5-108 MHz / DAB 174-223 MHz
SAT : 950-2400 MHz

- Résistance d'isolement : norme CEI 61169-24

7.4 Caractéristiques climatiques

Températures de stockage : - 10°C à + 70°C

Températures d'utilisation : - 5°C à + 35°C

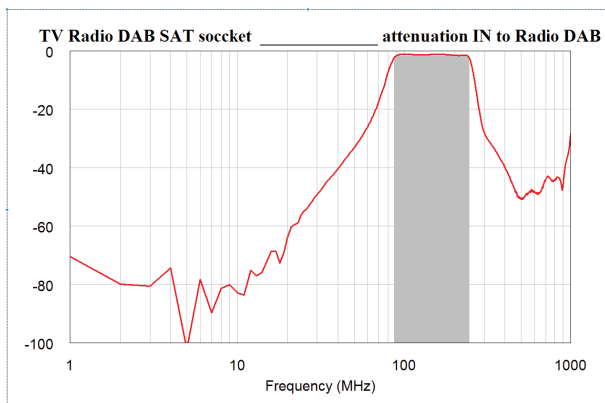
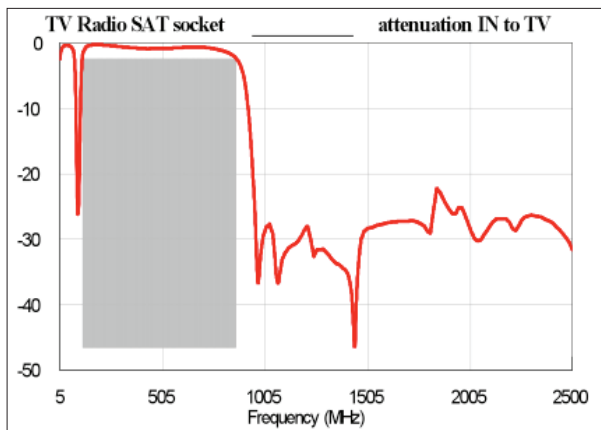
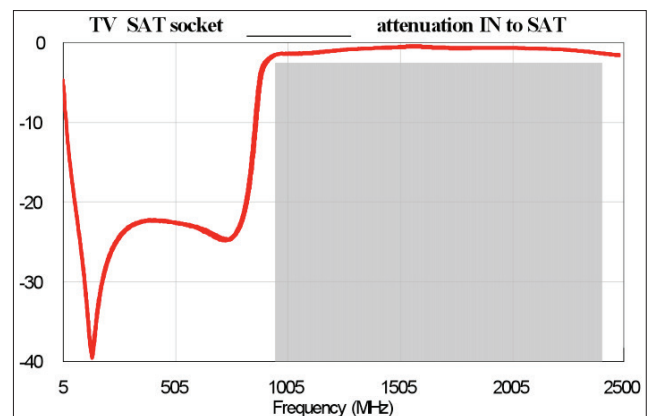
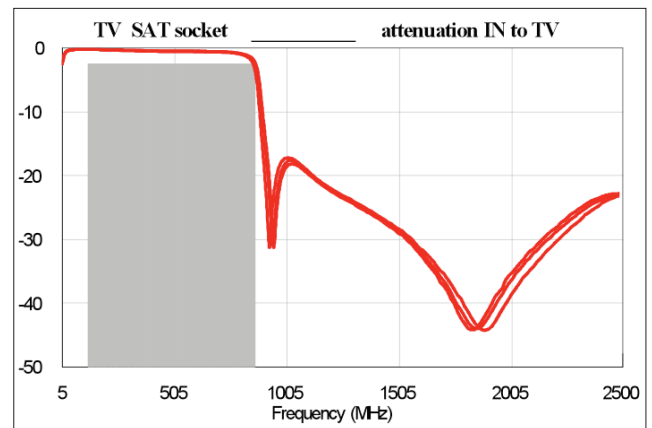
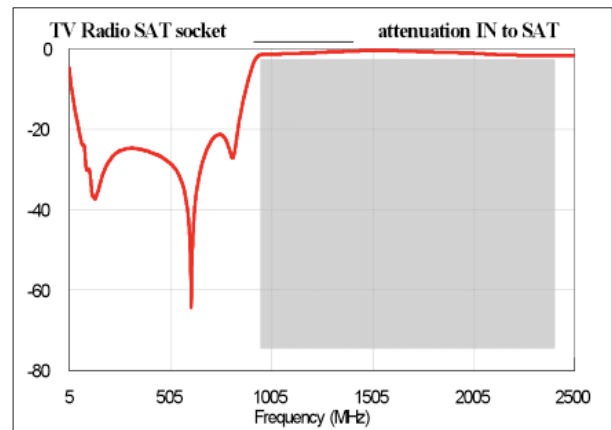
8. PERFORMANCE**8. PERFORMANCE (suite)**

9. NORMES ET AGREMENTS

- EN 50083-2
- Certificat Classe A

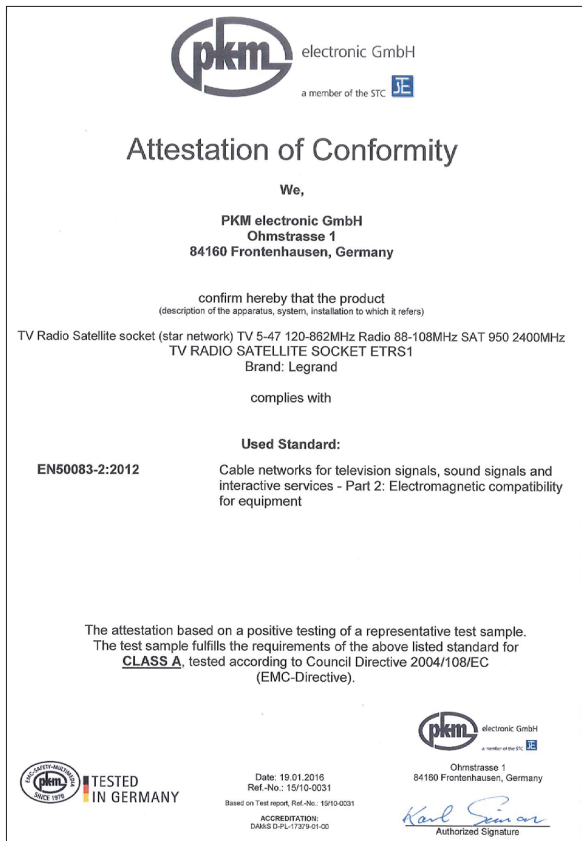

pkml electronic GmbH
a member of the STC 

Attestation of Conformity

We,
PKM electronic GmbH
Ohmstrasse 1
84160 Frontenhausen, Germany

confirm hereby that the product
(description of the apparatus, system, installation to which it refers)
TV Radio Satellite socket (star network) TV 5-47 120-862MHz Radio 88-108MHz SAT 950 2400MHz
TV RADIO SATELLITE SOCKET ETRS1
Brand: Legrand



complies with

Used Standard:
EN50083-2:2012 Cable networks for television signals, sound signals and interactive services - Part 2: Electromagnetic compatibility for equipment

The attestation based on a positive testing of a representative test sample.
The test sample fulfills the requirements of the above listed standard for **CLASS A**, tested according to Council Directive 2004/108/EC (EMC-Directive).

 **TESTED IN GERMANY**

Date: 19.01.2016
Ref.-No.: 15/10-0031
Based on Test report, Ref.-No.: 15/10-0031
ACCREDITATION: DAB5 D-PL-17379-01-00

 electronic GmbH
a member of the STC 
Ohmstrasse 1
84160 Frontenhausen, Germany
Karl Simon
Authorized Signature

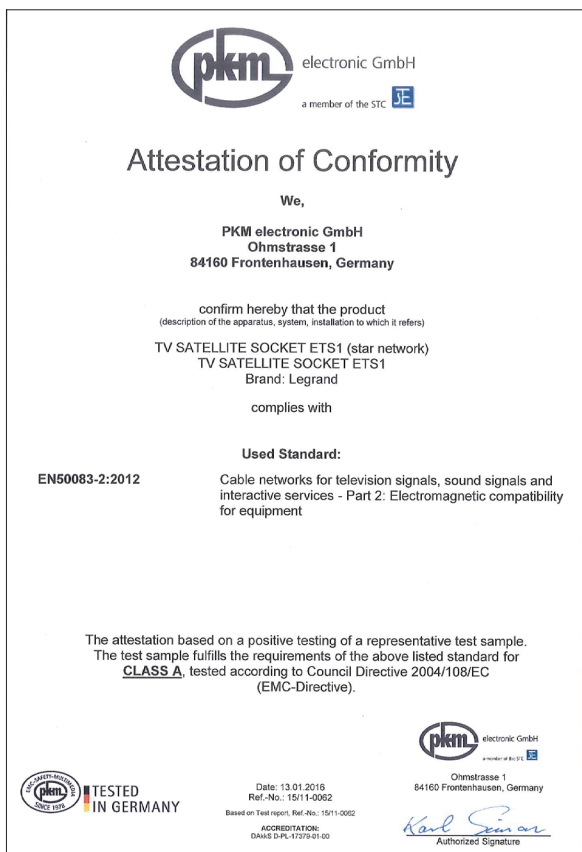

pkml electronic GmbH
a member of the STC 

Attestation of Conformity

We,
PKM electronic GmbH
Ohmstrasse 1
84160 Frontenhausen, Germany

confirm hereby that the product
(description of the apparatus, system, installation to which it refers)
TV SATELLITE SOCKET ETS1 (star network)
TV SATELLITE SOCKET ETS1
Brand: Legrand



complies with

Used Standard:
EN50083-2:2012 Cable networks for television signals, sound signals and interactive services - Part 2: Electromagnetic compatibility for equipment

The attestation based on a positive testing of a representative test sample.
The test sample fulfills the requirements of the above listed standard for **CLASS A**, tested according to Council Directive 2004/108/EC (EMC-Directive).

 **TESTED IN GERMANY**

Date: 13.01.2016
Ref.-No.: 15/11-0062
Based on Test report, Ref.-No.: 15/11-0062
ACCREDITATION: DAB5 D-PL-17379-01-00

 electronic GmbH
a member of the STC 
Ohmstrasse 1
84160 Frontenhausen, Germany
Karl Simon
Authorized Signature